

Project Name		Customer Name	
Quote Number		Date	
Customization			

Standard Features

Type	One-piece roll-in type shower stall with simulated 12" x 24" tile design. Available in left or right hand configuration.
Color	White
Exterior Dimensions	63"W x 36"D x 79-1/2"H
Materials	Gel coat and fiberglass composite
Approximate Weight	145 lbs

Certifications and Accessibility Code Compliance



Universal Plumbing Code



CSA B45.5-11 / IAPMO Z124-2017



ADA

ANSI

ICC A117.1 - 2017 ANSI Type A



California Title 24

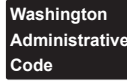

WAC 388-78A-3030



HUD / FHA

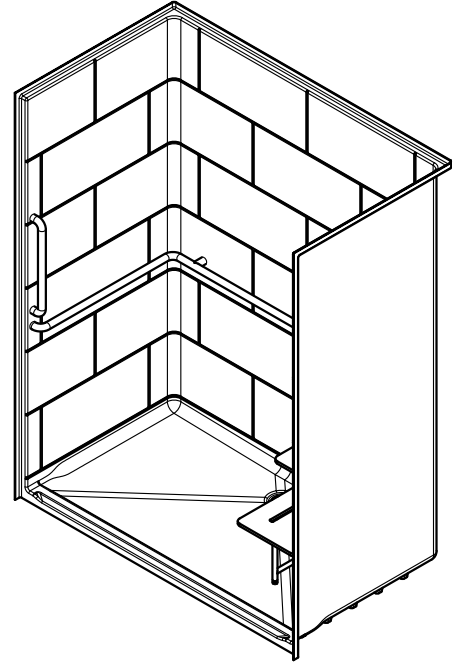

Warranty

30 Year Limited

Reinforcement

Fully reinforced with EverFab's unique composite core material which allows for factory or field installation of ADA compliant grab bars and seat

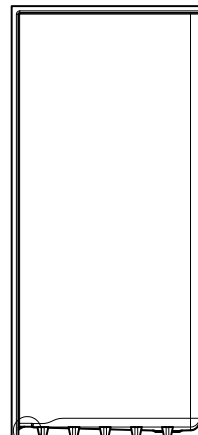
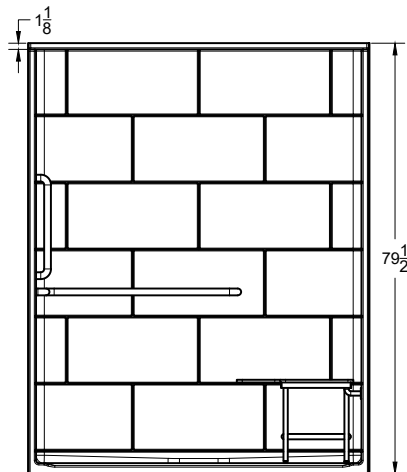
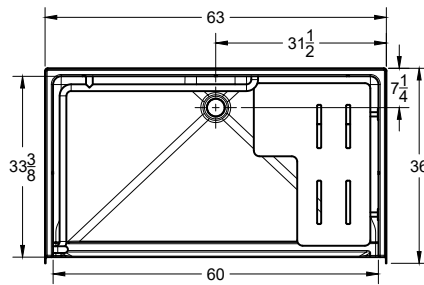

Threshold Detail (See Submittal Page 3)

Reinforcing Bottom Plate

Due to the nature of the material, all measurements may vary by $\pm 3/8"$.
Dimensions needed for site preparation should be measured from the unit.

ADA Accessory Dimensions

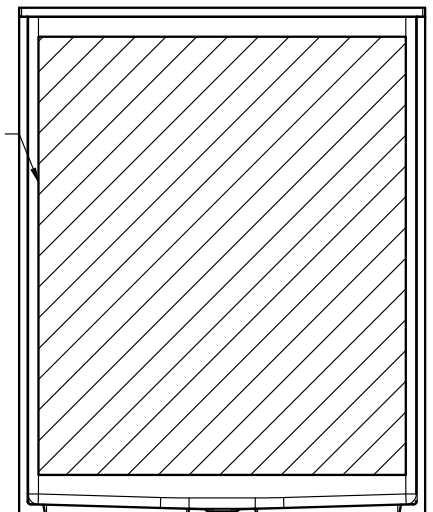
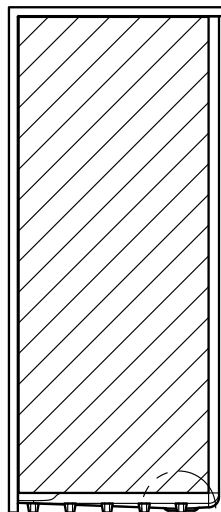
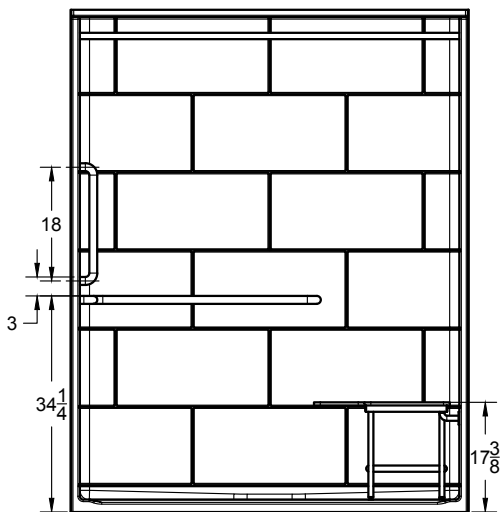
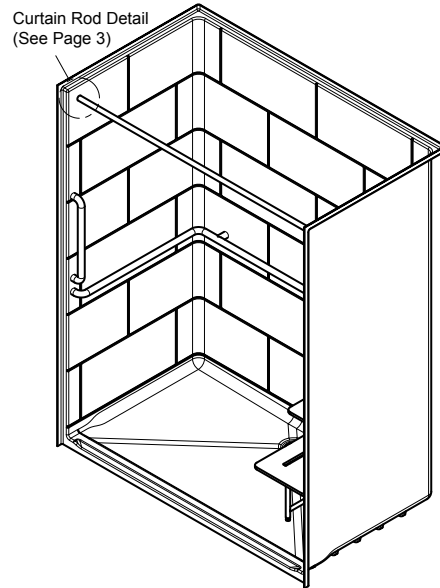
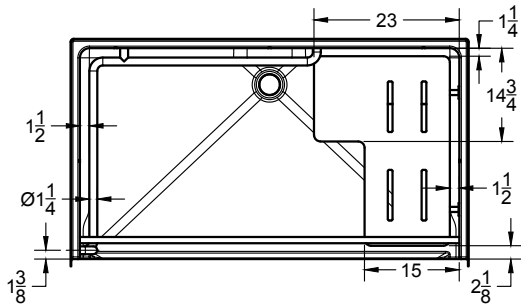

Drain Block Out Detail
(See Submittal Page 3)

Architectural Specifications

A. Shower Stall:

1. Model: No. S6336TA-L/R
2. Description: One-piece shower stall with reinforcing bottom plate, slip-resistant floor, simulated 12" x 24" tile, and inorganic composite reinforcement for placement of grab bars and seat
3. Exterior dimensions: 63 inches wide x 36 inches deep x 79-1/2 inches high
4. Rough-in: +1/8" -0" nominal dimensions
5. Threshold: [Standard] [Low Profile] [No-Recess] Threshold Detail
6. Accessibility Accessories: [A0] [A1] [A2] [A3] [Custom] accessory configuration
7. Optional Accessories: Furnish with [curtain rod], [shower curtain], [recessed soap dish], [composite corner shelf], [shower slide-bar kit], [EverFab tub-wrap], [shower drain], [18" grab bar], [24" grab bar], [folding seat], [T-shaped EverDam]. If applicable, please indicate location of additional accessories on drawing
8. Accessory Style: [A0 - No Accessories], [Standard Thru-Bolted], [Flanged], [Elite Series], [Anti-Ligature], [Custom]
9. Accessory Finish: [A0 - No Accessories], [Standard Satin Stainless], [Matte Black], [Polished Stainless] [White], [Custom]

ADA Accessory Configurations (number following 'A' indicates configuration)

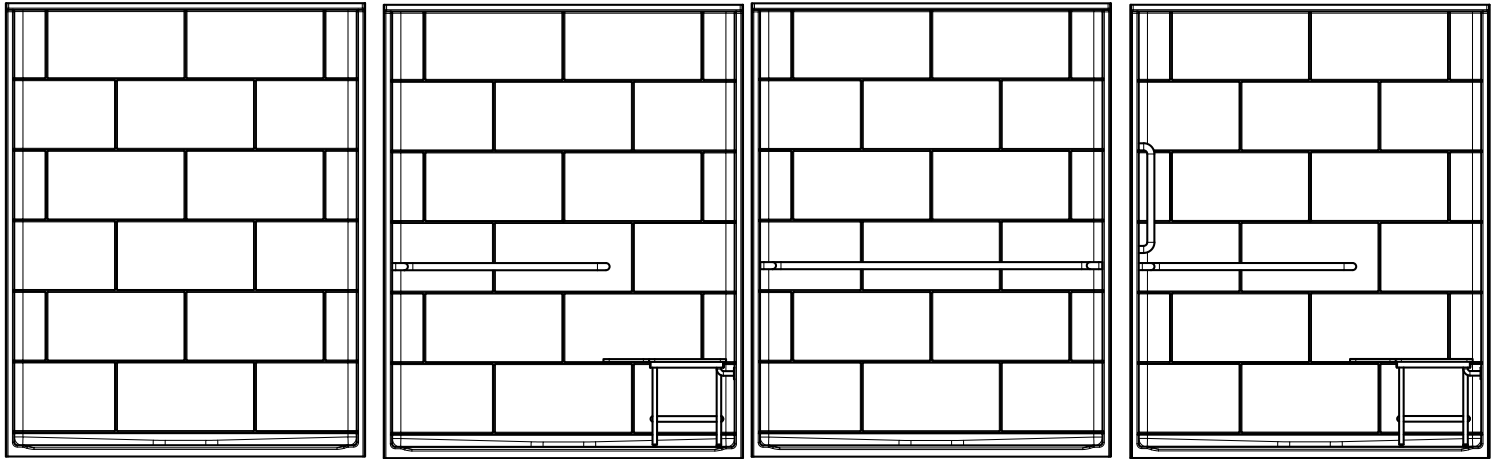

S6336TA0

No Accessories

S6336TA1-R

L-shaped grab bar
Seat

S6336TA2

U-shaped grab bar

S6336TA3-R

L-shaped grab bar
Seat
18" vertical grab bar

Threshold Details

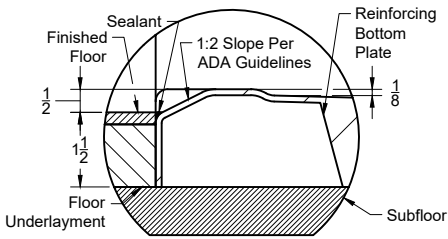

Standard

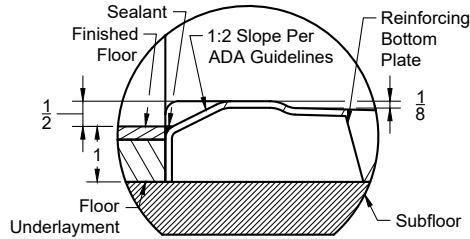

Low-Profile

Model number followed with 'LP'

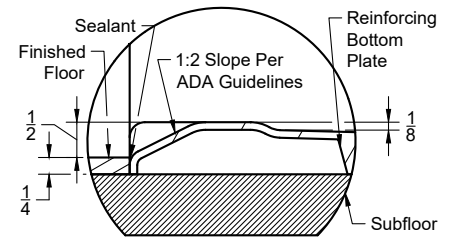

No-Recess

Model number followed with 'NR'

Additional Details

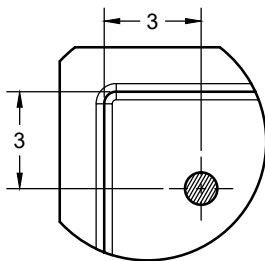

Standard Curtain Rod Location

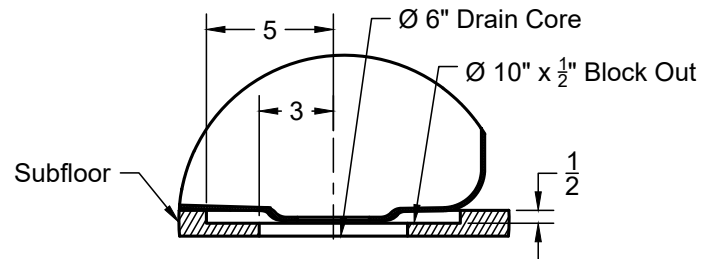

Drain Block-Out

Standard Threshold Models

Model Number	Pre-Installed L-Shaped Grab Bar	Pre-Installed 18" Vertical Grab Bar	Pre-Installed U-Shaped Grab Bar	Pre-Installed Folding Seat	Drain Block Out Required	Accessibility Code Compliance
<input type="checkbox"/> S6336TA0	No	No	No	No	No	Adaptable**
<input type="checkbox"/> S6336TA1	Yes	No	No	Yes	No	ADA, CA Title 24, WAC, HUD/FHA
<input type="checkbox"/> S6336TA2	No	No	Yes	No	No	ADA, CA Title 24, WAC, HUD/FHA
<input type="checkbox"/> S6336TA3	Yes	Yes	No	Yes	No	ADA, CA Title 24, WAC, ANSI, HUD/FHA

Low Profile Threshold Models

Model Number	Pre-Installed L-Shaped Grab Bar	Pre-Installed 18" Vertical Grab Bar	Pre-Installed U-Shaped Grab Bar	Pre-Installed Folding Seat	Drain Block Out Required	Accessibility Code Compliance
<input type="checkbox"/> S6336TA0LP	No	No	No	No	Yes	Adaptable**
<input type="checkbox"/> S6336TA1LP	Yes	No	No	Yes	Yes	ADA, CA Title 24, WAC, HUD/FHA
<input type="checkbox"/> S6336TA2LP	No	No	Yes	No	Yes	ADA, CA Title 24, WAC, HUD/FHA
<input type="checkbox"/> S6336TA3LP	Yes	Yes	No	Yes	Yes	ADA, CA Title 24, WAC, ANSI, HUD/FHA

No-Recess Threshold Models

Model Number	Pre-Installed L-Shaped Grab Bar	Pre-Installed 18" Vertical Grab Bar	Pre-Installed U-Shaped Grab Bar	Pre-Installed Folding Seat	Drain Block Out Required	Accessibility Code Compliance
<input type="checkbox"/> S6336TA0NR	No	No	No	No	Yes	Adaptable**
<input type="checkbox"/> S6336TA1NR	Yes	No	No	Yes	Yes	ADA, CA Title 24, WAC, HUD/FHA
<input type="checkbox"/> S6336TA2NR	No	No	Yes	No	Yes	ADA, CA Title 24, WAC, HUD/FHA
<input type="checkbox"/> S6336TA3NR	Yes	Yes	No	Yes	Yes	ADA, CA Title 24, WAC, ANSI, HUD/FHA

**Model is reinforced and capable of meeting accessibility code requirements with proper field-installation of grab bars and seat

Seat Placement (indicated by '-L' or '-R' following model number)*

- Left Hand Right Hand

*Seat placement is determined as if outside the unit looking in. For clarity, a right hand model is shown in all drawings

Optional Accessories†

- | | |
|---|---|
| <input type="checkbox"/> Curtain Rod | <input type="checkbox"/> Shower Drain |
| <input type="checkbox"/> Shower Curtain | <input type="checkbox"/> 18" grab bar |
| <input type="checkbox"/> Recessed Soap Dish | <input type="checkbox"/> 24" grab bar |
| <input type="checkbox"/> Composite Corner Shelf | <input type="checkbox"/> Folding seat |
| <input type="checkbox"/> Shower Slide-Bar Kit | <input type="checkbox"/> T-shaped EverDam |
| <input type="checkbox"/> EverFab Tub-Wrap | |

Accessory Style

- Thu-bolted (Standard)
 Flanged
 Elite Series
 Anti-ligature
 Custom, please specify:

Accessory Finish

- Satin Stainless (Standard)
 Matte Black
 Polished Stainless
 White
 Custom, please specify:

†If applicable, please select accessory style and finish from options above. If custom, please also indicate desired location(s) on drawing.