

Project Name		Customer Name	
Quote Number		Date	
Customization			

Standard Features

Type	One-piece transfer type shower stall with return flange. Available in right or left hand configuration.
Color	White
Exterior Dimensions	38"W x 38"D x 78-1/2"H
Materials	Gel coat and fiberglass composite
Approximate Weight	130 lbs

Certifications and Accessibility Code Compliance

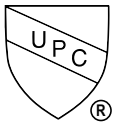

Universal Plumbing Code



CSA B45.5-11 / IAPMO Z124-2017



ADA

ANSI

ICC A117.1 - 2017 ANSI Type A



HUD / FHA

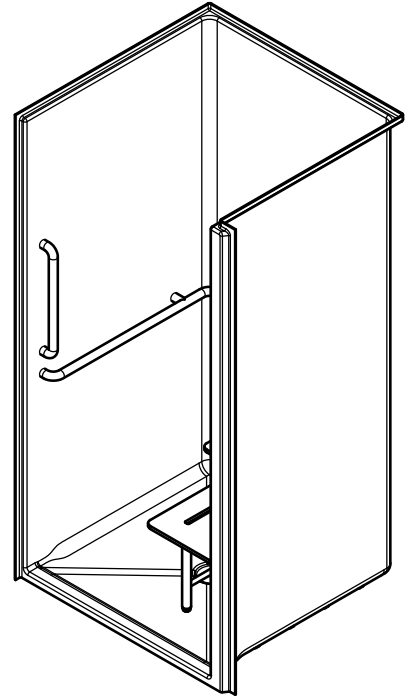

Warranty

30 Year Limited

Reinforcement

Fully reinforced with EverFab's unique composite core material which allows for factory or field installation of ADA compliant grab bars and seat

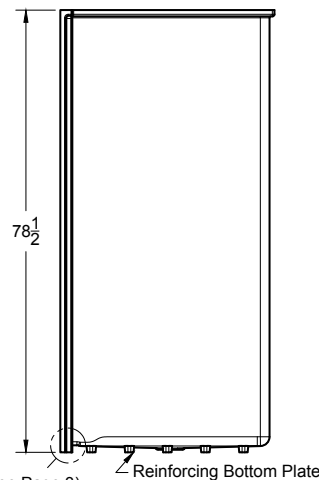
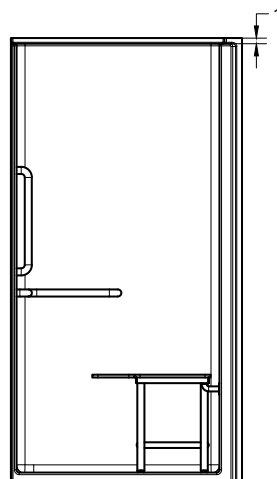
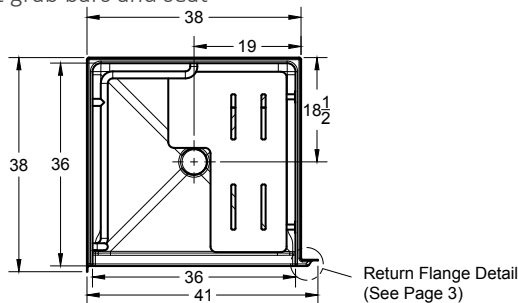

ADA Accessory Dimensions

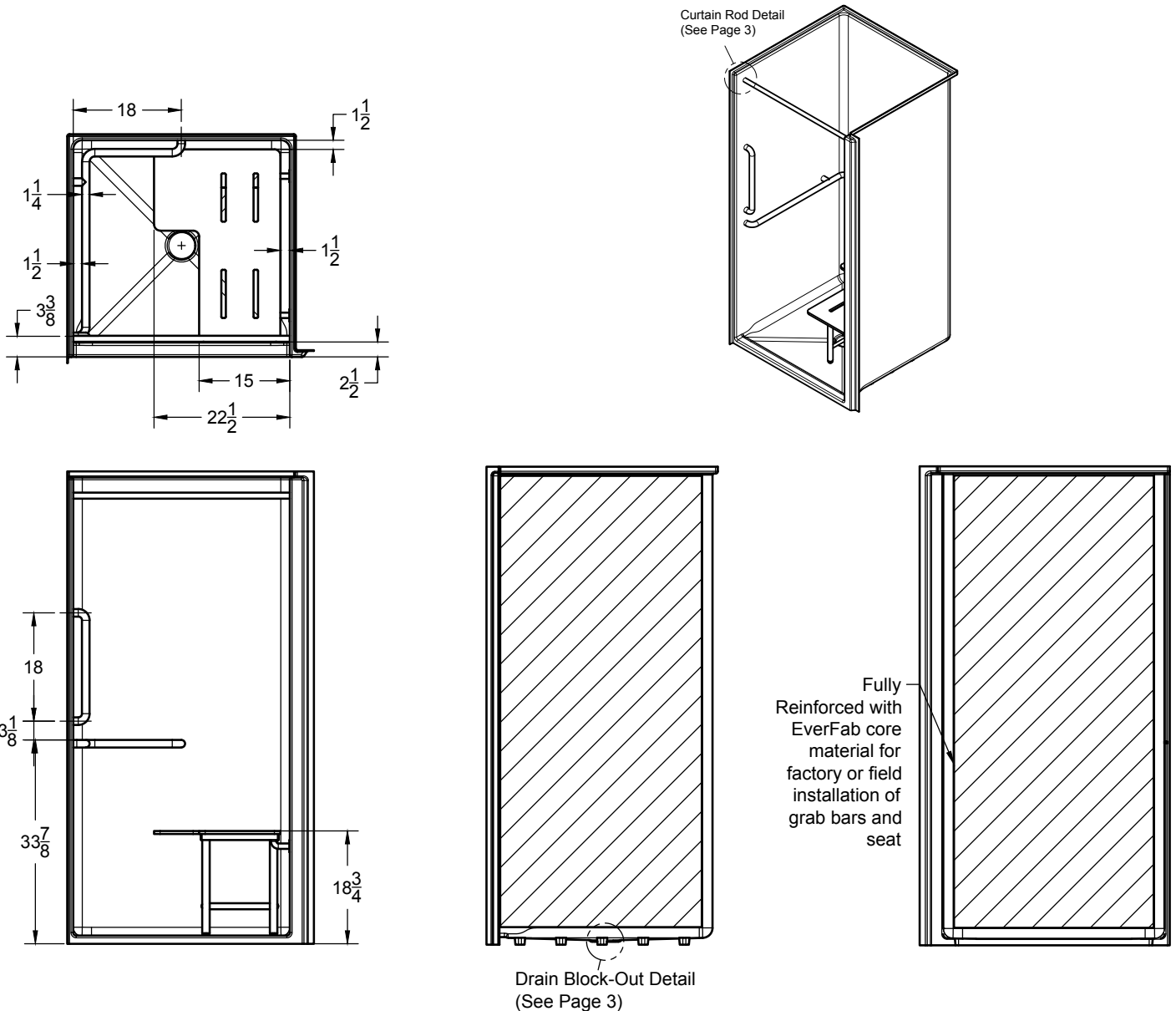

Architectural Specifications

A. Shower Stall:

1. Model: No. S3838RFA-L/R
2. Description: One-piece shower stall with reinforcing bottom plate, slip-resistant floor, return flange, and inorganic composite reinforcement for placement of grab bars and seat
3. Exterior dimensions: 38 inches wide x 41 inches deep x 78-1/2 inches high
4. Rough-in: +1/8" -0" nominal dimensions
5. Threshold: [Standard] [Low Profile] Threshold Detail
6. Accessibility Accessories: [A0] [A1] [Custom] accessory configuration
7. Optional Accessories: Furnish with [curtain rod], [shower curtain], [recessed soap dish], [composite corner shelf], [shower slide-bar kit], [EverFab tub-wrap], [shower drain], [18" grab bar], [24" grab bar], [custom grab bar], [folding seat], [T-shaped EverDam]. If applicable, please indicate location of additional accessories on drawing
8. Accessory Style: [A0 - No Accessories], [Standard Thru-Bolted], [Flanged], [Elite Series], [Anti-Ligature], [Custom]
9. Accessory Finish: [A0 - No Accessories], [Standard Satin Stainless], [Matte Black], [Polished Stainless] [White], [Custom]

ADA Accessory Configurations (number following 'A' indicates configuration)

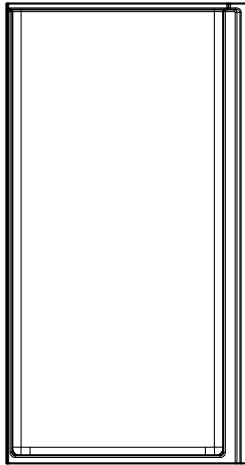

S3838RFA0-R

No Accessories

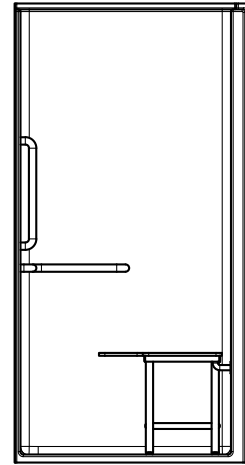

S3838RFA1-R

L-shaped grab bar

Seat

18" vertical grab bar

Threshold Details

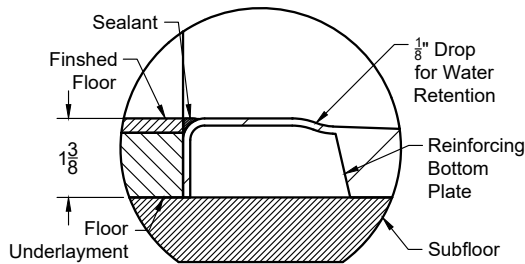

Standard

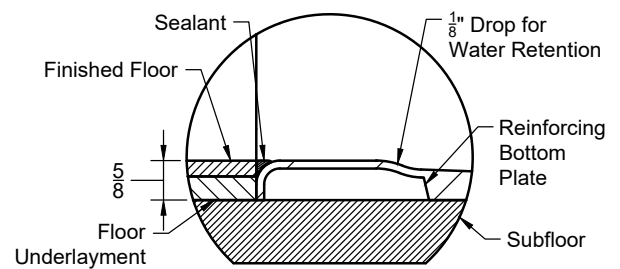

Low-Profile

Model number followed with 'LP'

Additional Details

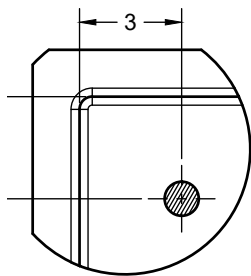

Standard Curtain Rod Location

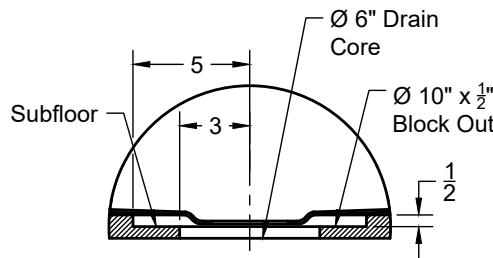

Drain Block-Out

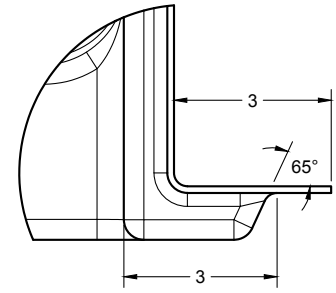

Return Flange

Standard Threshold Models

Model Number	Pre-Installed L-Shaped Grab Bar	Pre-Installed 18" Vertical Grab Bar	Pre-Installed Folding Seat	Drain Block Out Required	Accessibility Code Compliance
<input type="checkbox"/> S3838RFA0	No	No	No	No	Adaptable**
<input type="checkbox"/> S3838RFA1	Yes	Yes	Yes	No	ADA, ANSI, HUD/FHA

Low Profile Threshold Models

Model Number	Pre-Installed L-Shaped Grab Bar	Pre-Installed 18" Vertical Grab Bar	Pre-Installed Folding Seat	Drain Block Out Required	Accessibility Code Compliance
<input type="checkbox"/> S3838RFA0LP	No	No	No	Yes	Adaptable**
<input type="checkbox"/> S3838RFA1LP	Yes	Yes	Yes	Yes	ADA, ANSI, HUD/FHA

***Model is reinforced and capable of meeting accessibility code requirements with proper field-installation of grab bars and seat*

Flange and Seat (if applicable) Placement (indicated by '-L' or '-R' following model number)*

- Left Hand Right Hand

**Flange and seat placement is determined as if outside the unit looking in. For clarity, a right hand model is shown in all drawings.*

Optional Accessories†

- | | |
|---|---|
| <input type="checkbox"/> Curtain Rod | <input type="checkbox"/> Shower Drain |
| <input type="checkbox"/> Shower Curtain | <input type="checkbox"/> Custom grab bar, please specify: |
| <input type="checkbox"/> Recessed Soap Dish | <input type="checkbox"/> Folding seat |
| <input type="checkbox"/> Composite Corner Shelf | <input type="checkbox"/> T-Shaped EverDam |
| <input type="checkbox"/> Shower Slide-Bar Kit | |
| <input type="checkbox"/> EverFab Tub-Wrap | |

Accessory Style

- Thu-bolted (Standard)
 Flanged
 Elite Series
 Anti-ligature
 Custom, please specify:

Accessory Finish

- Satin Stainless (Standard)
 Matte Black
 Polished Stainless
 White
 Custom, please specify:

†If applicable, please select accessory style and finish from options above. If custom, please also indicate desired location(s) on drawing.